

Bouwplan "*Le Quartz par Christian Derefat*"

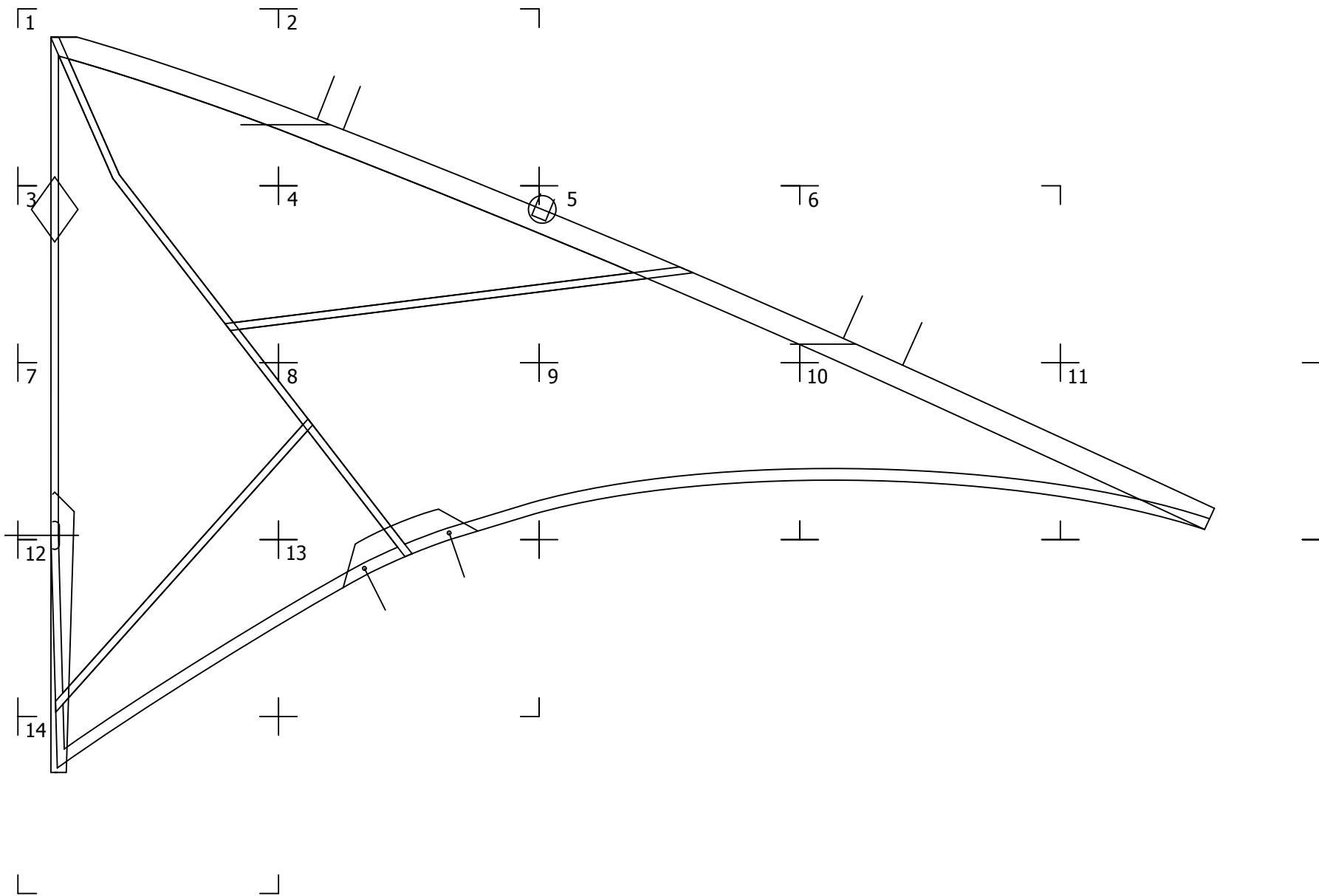

1

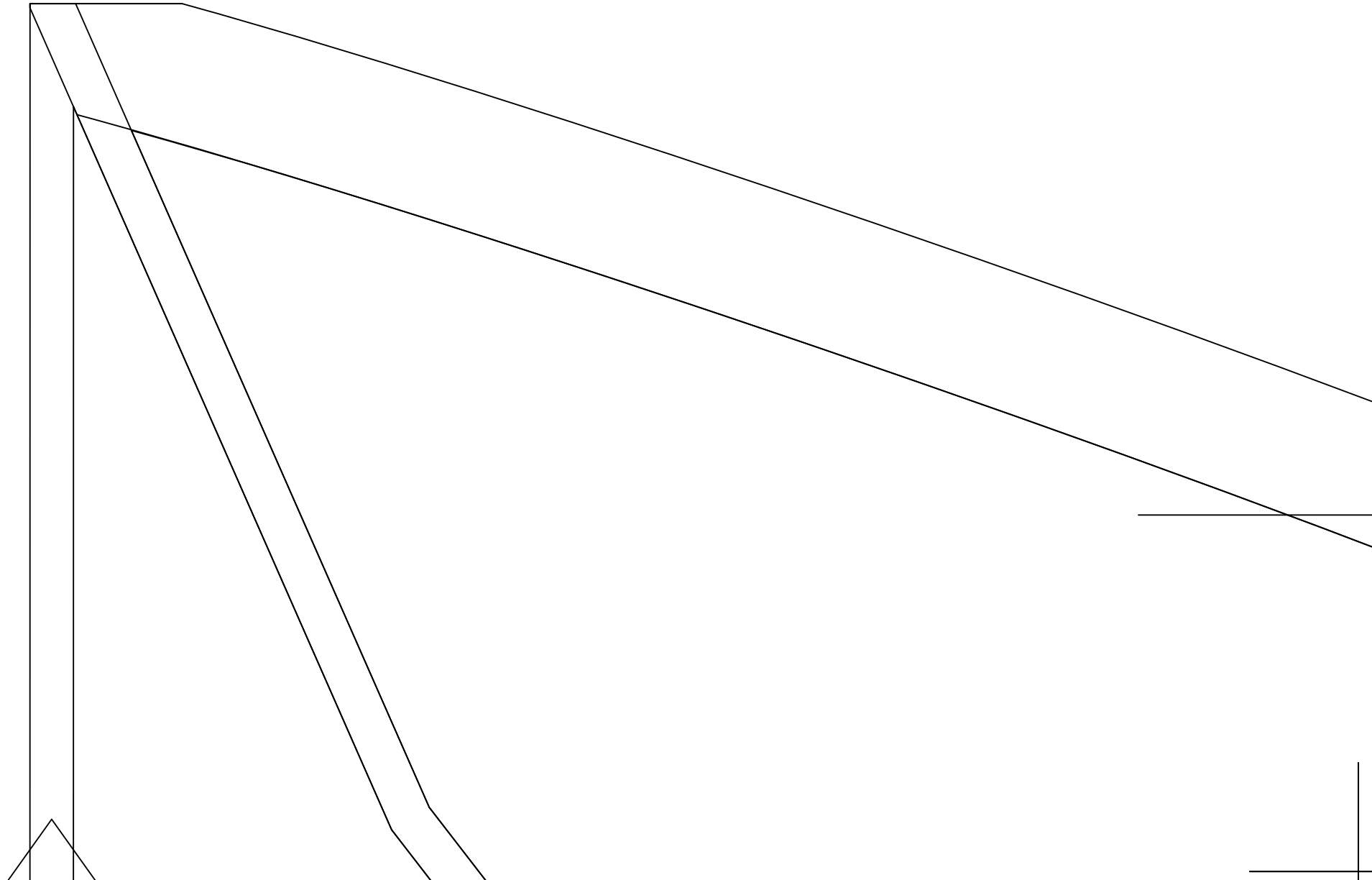

2

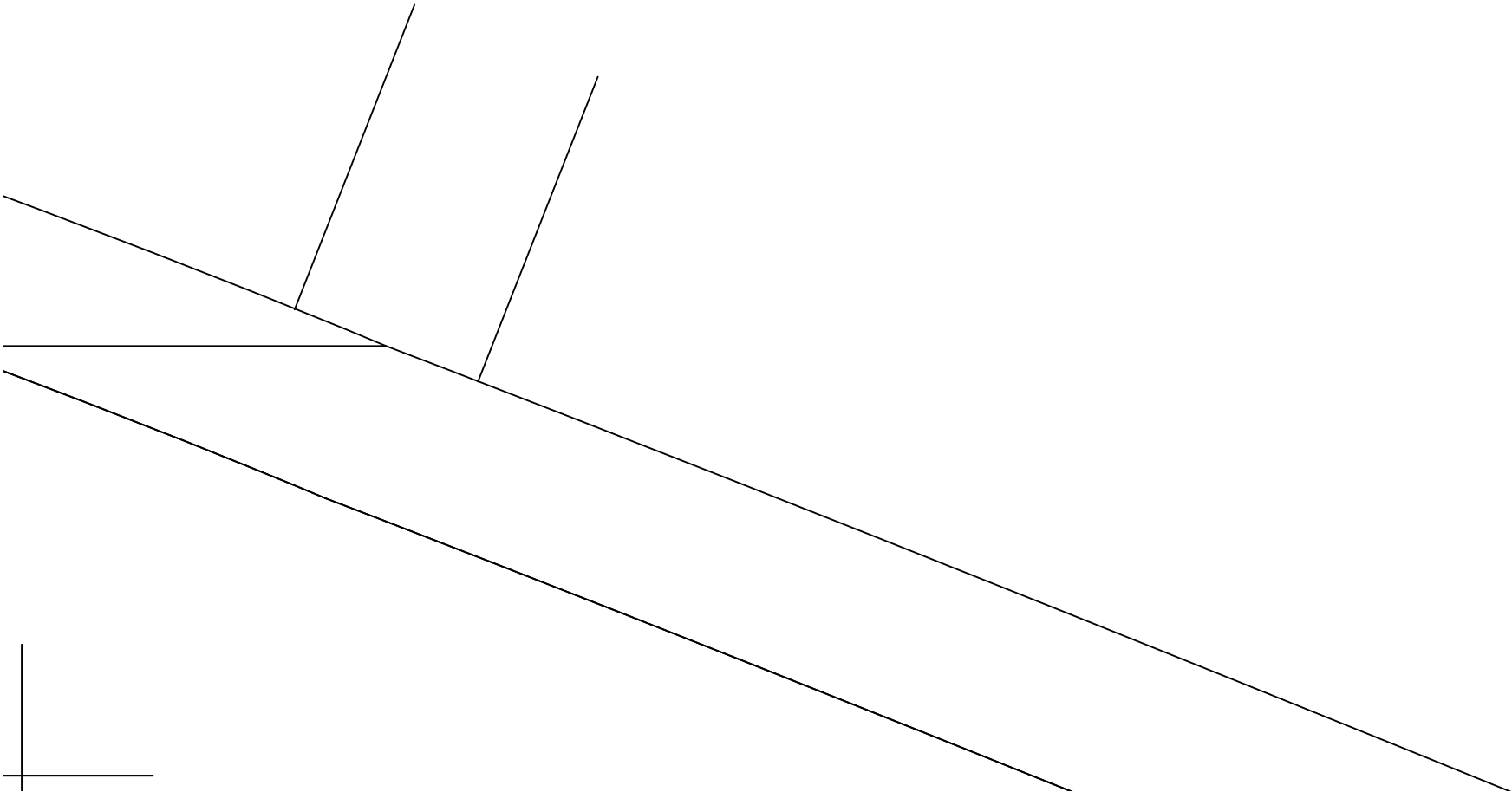
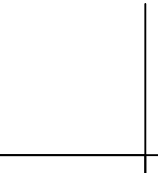
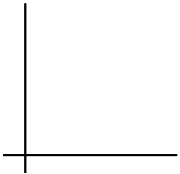

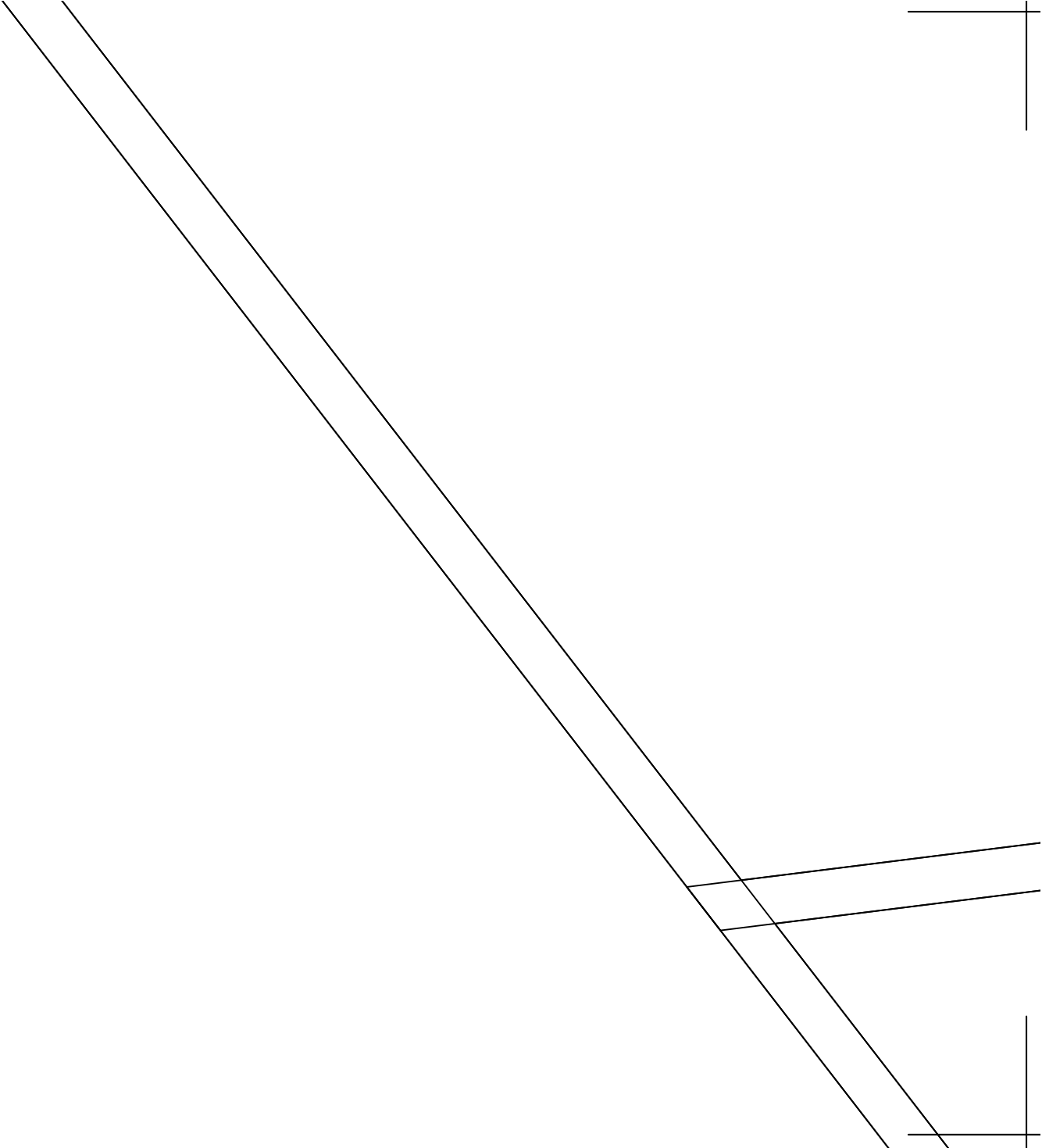
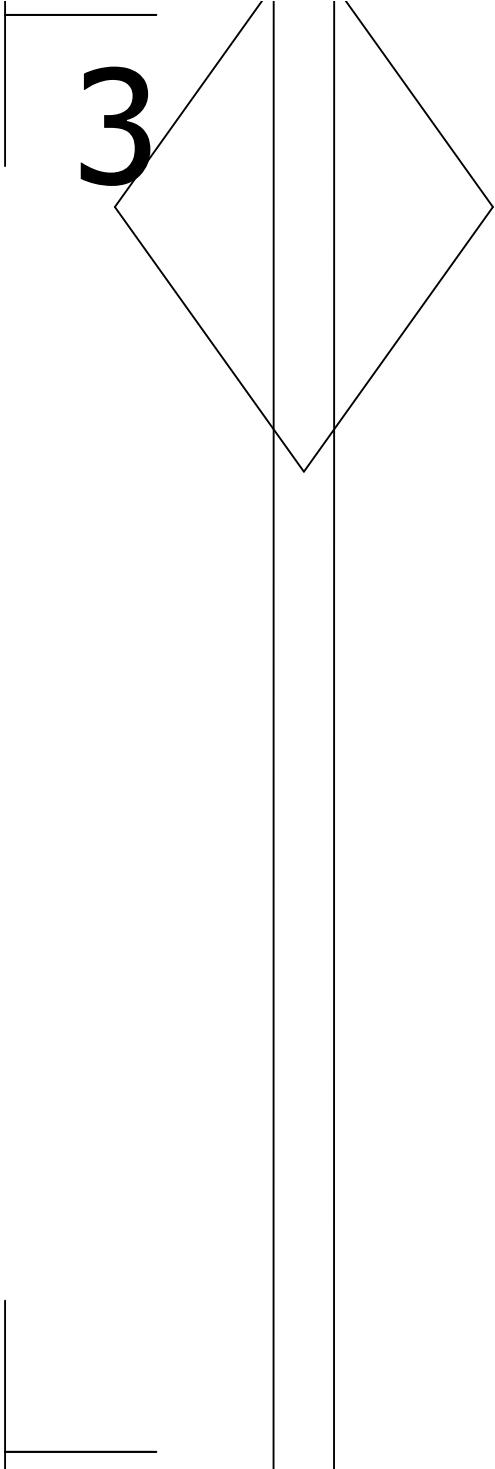

4

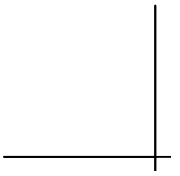
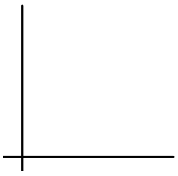
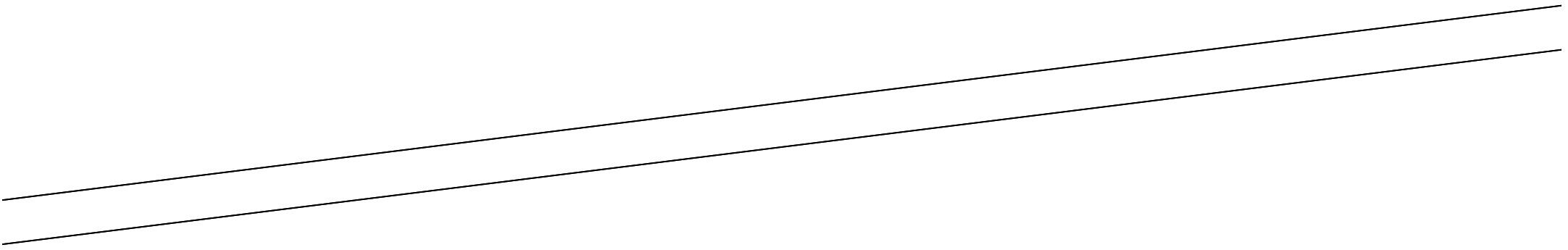

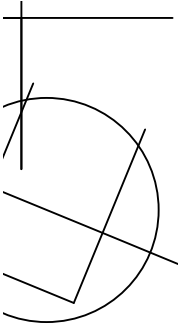

5

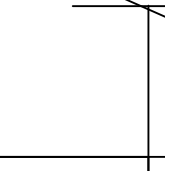
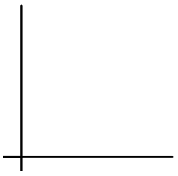
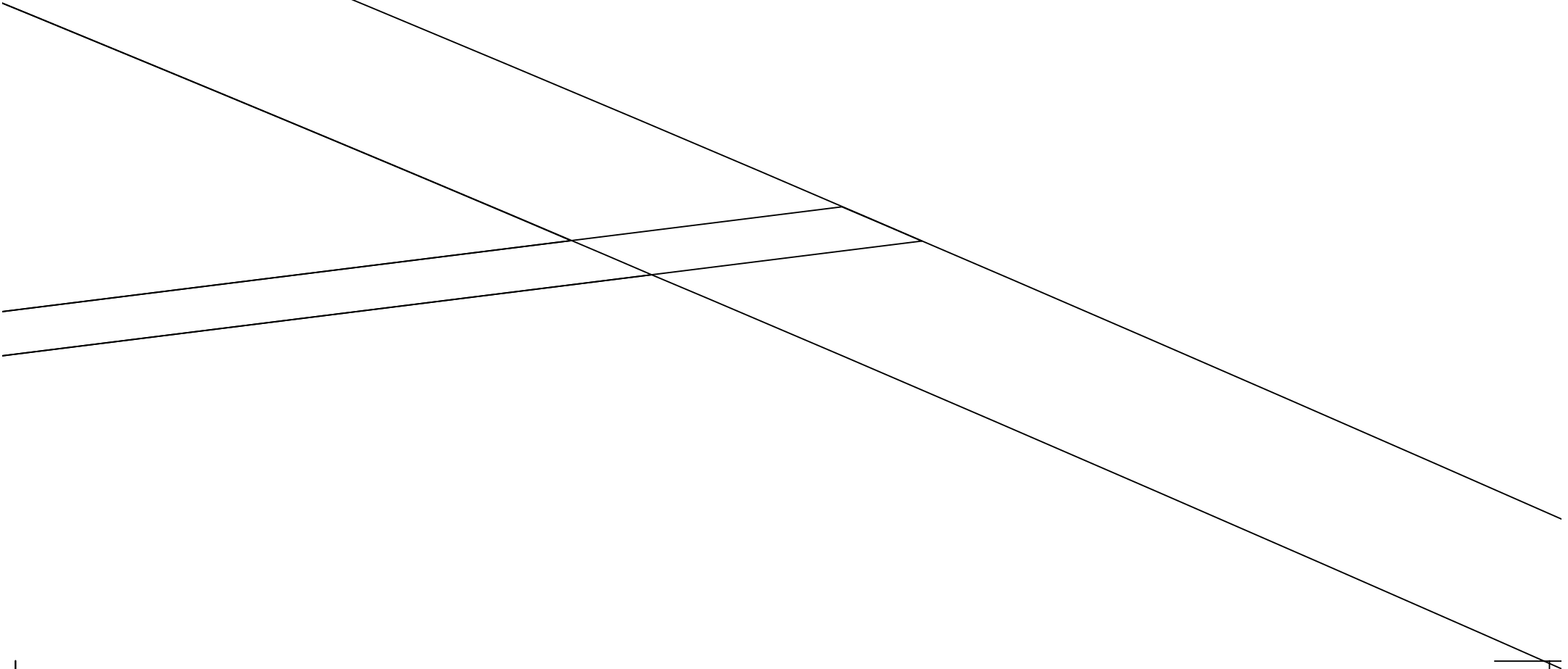

6

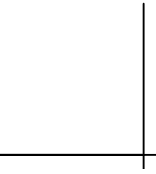
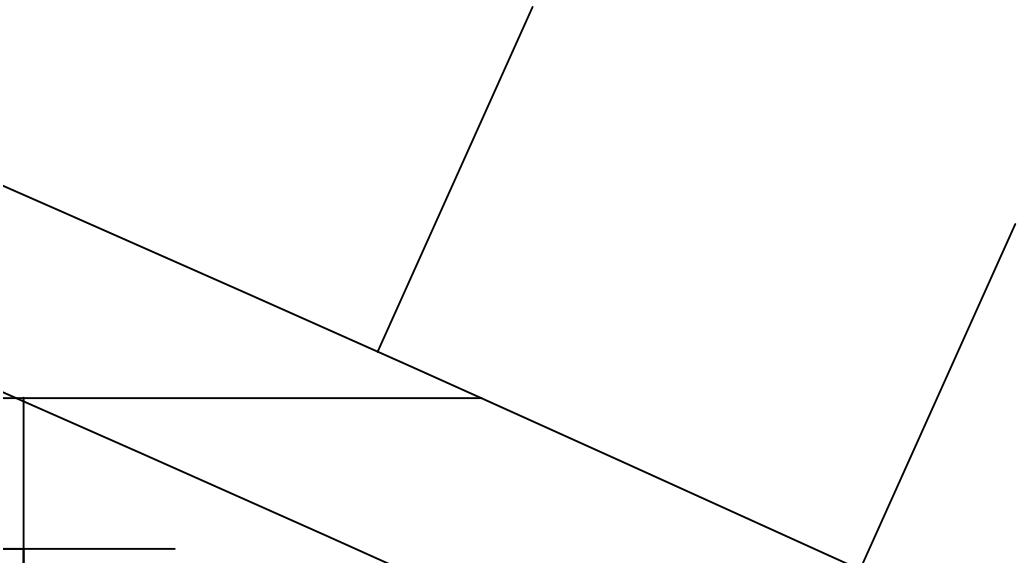
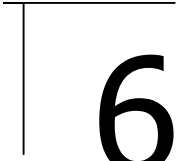

7

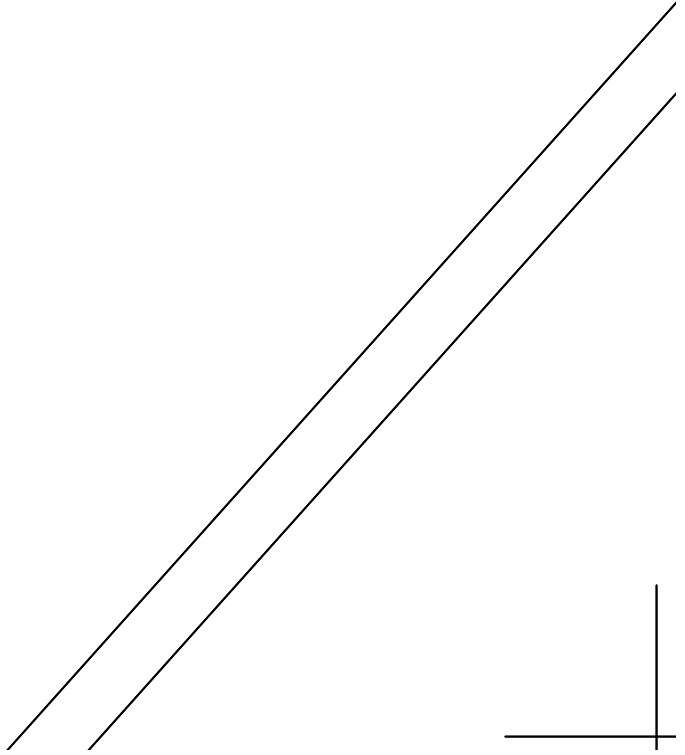
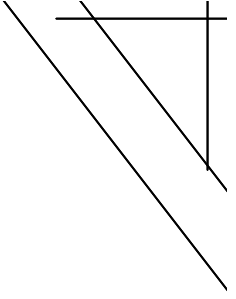
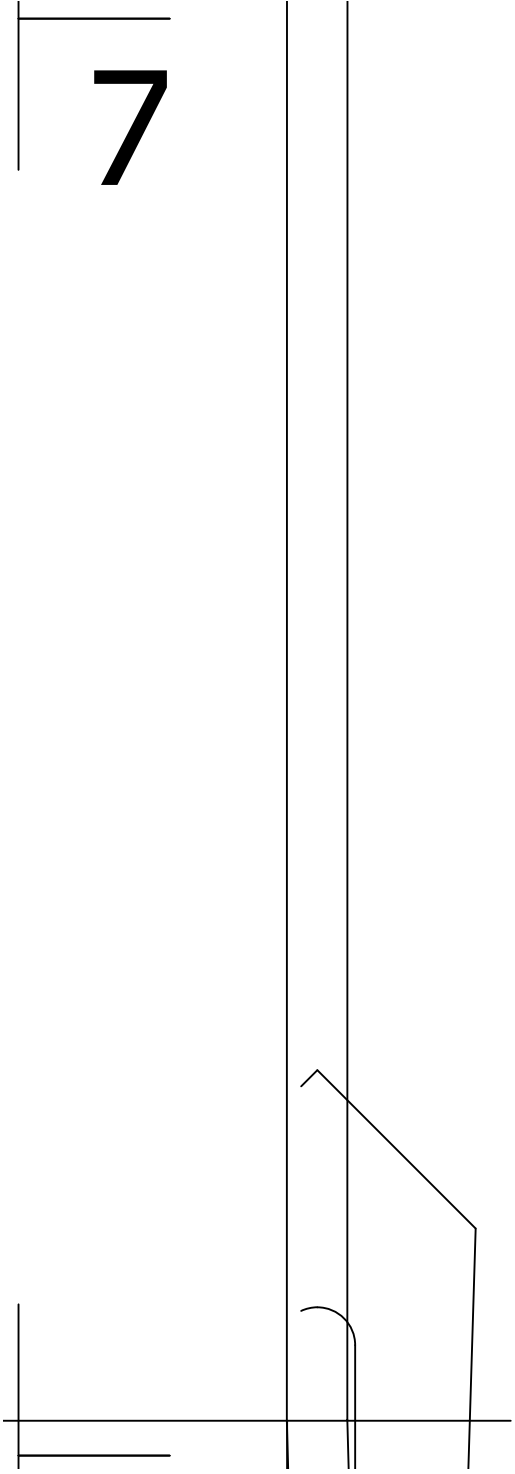

8

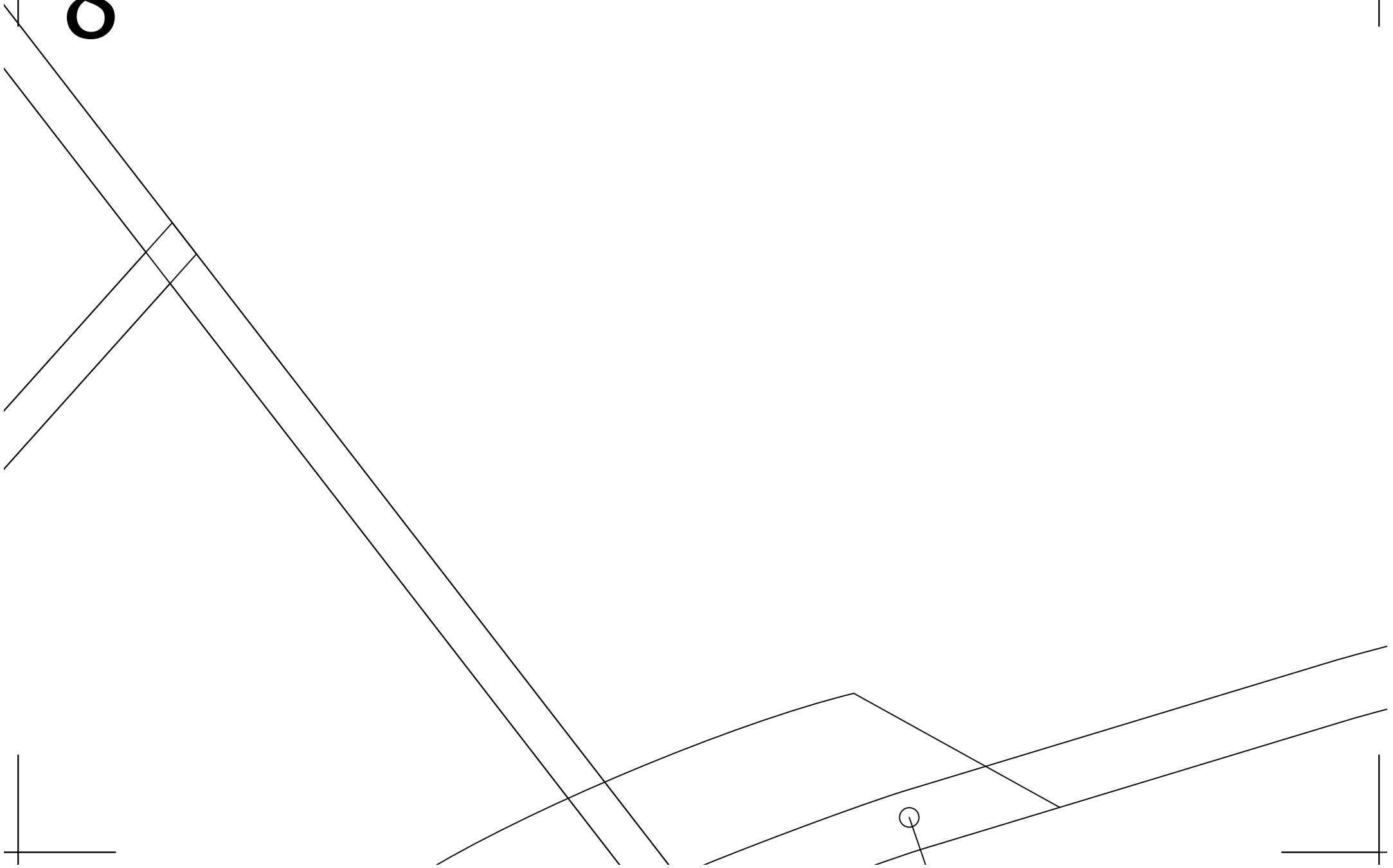
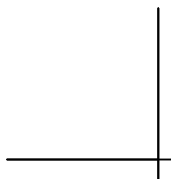
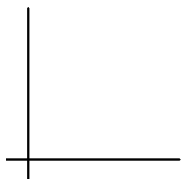
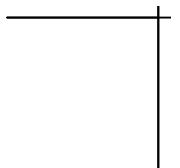
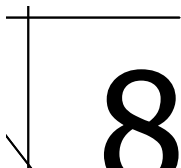

9

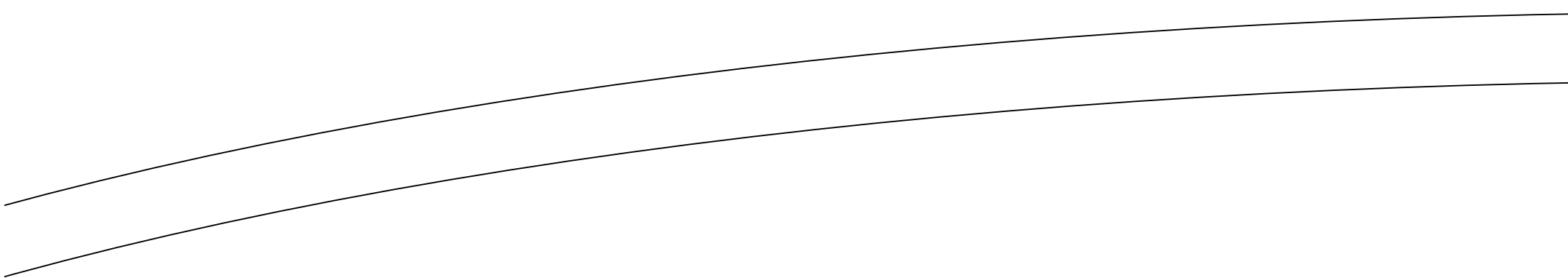
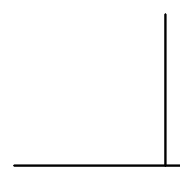
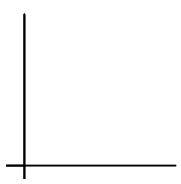
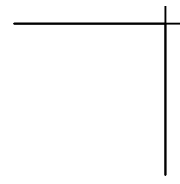
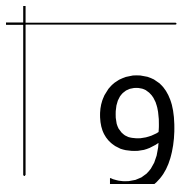

10

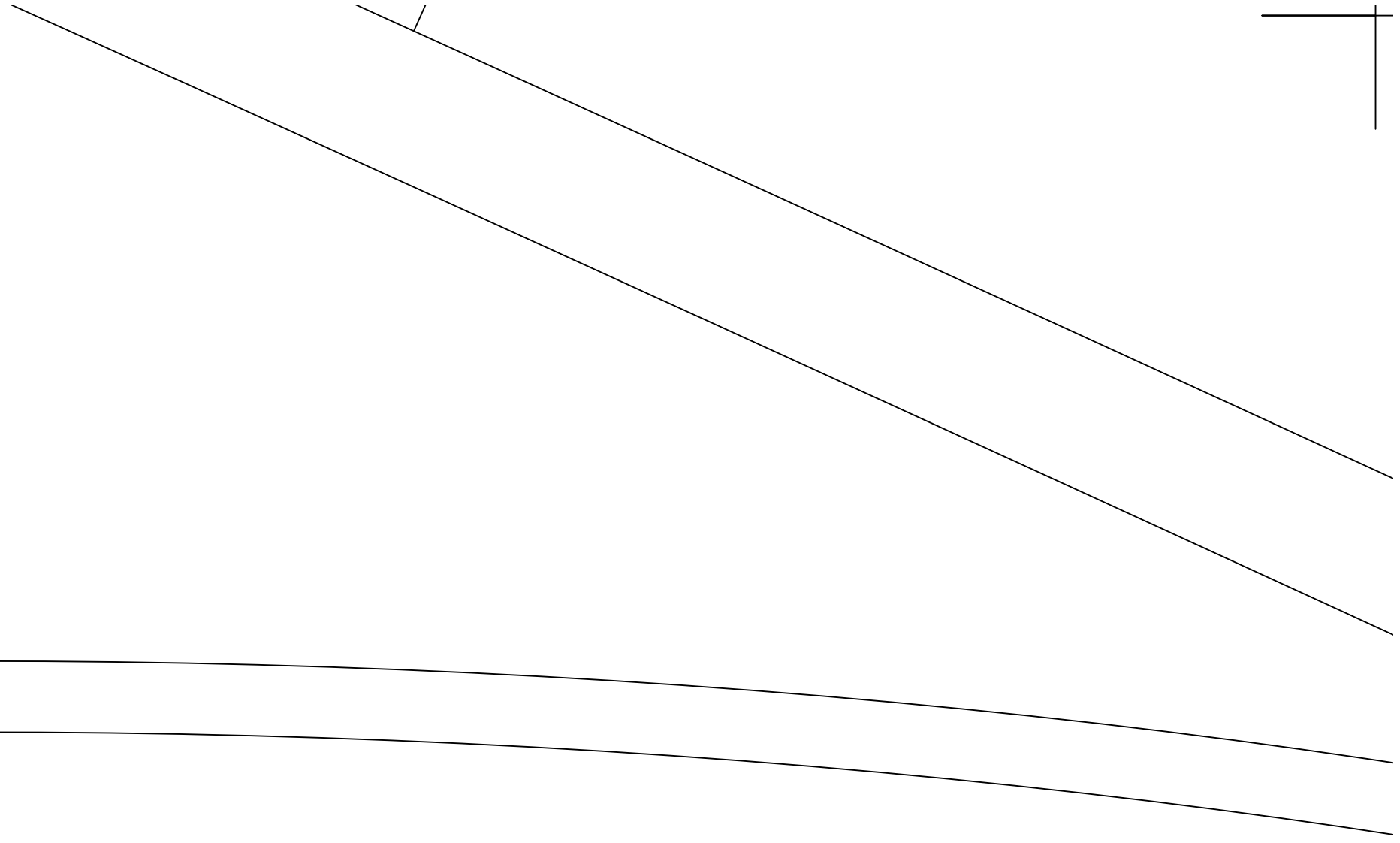

11

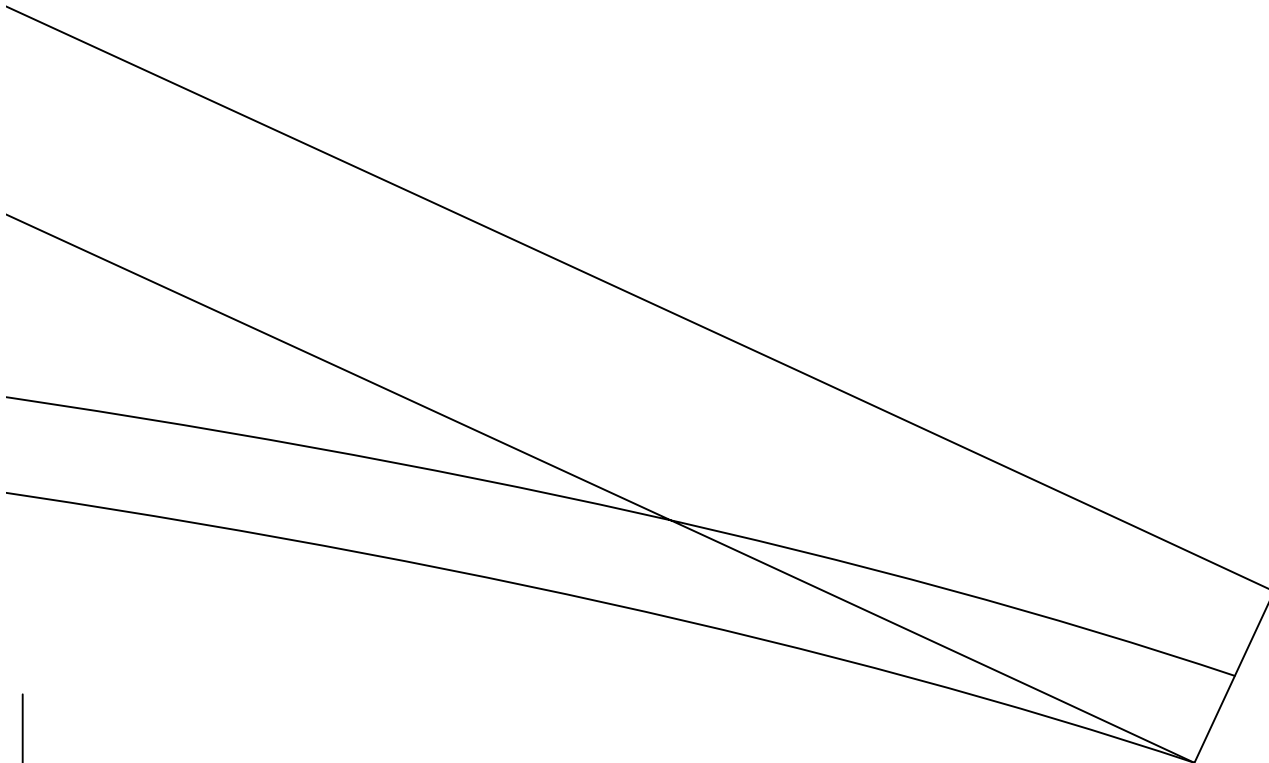

12

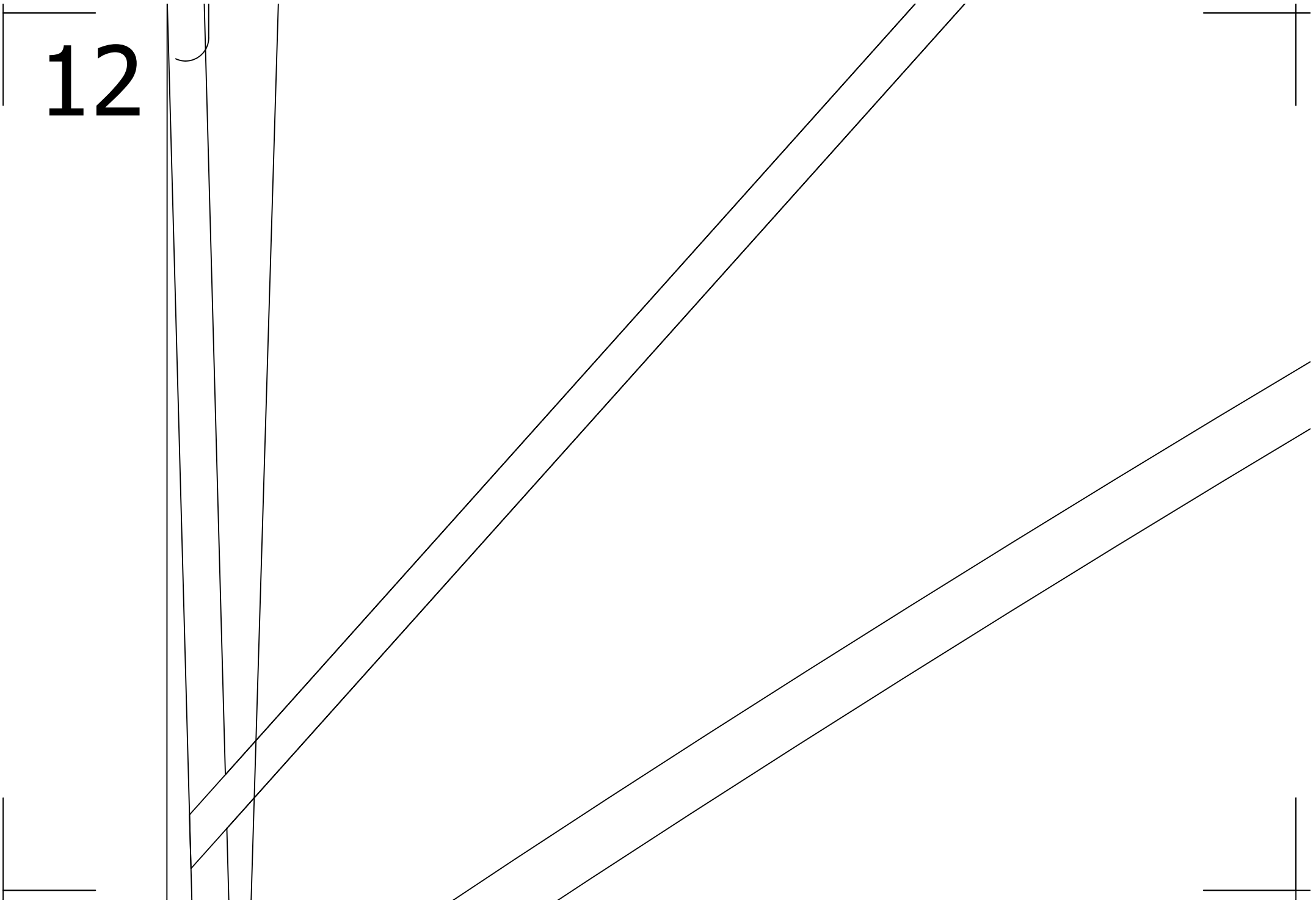

13

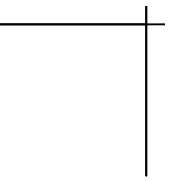
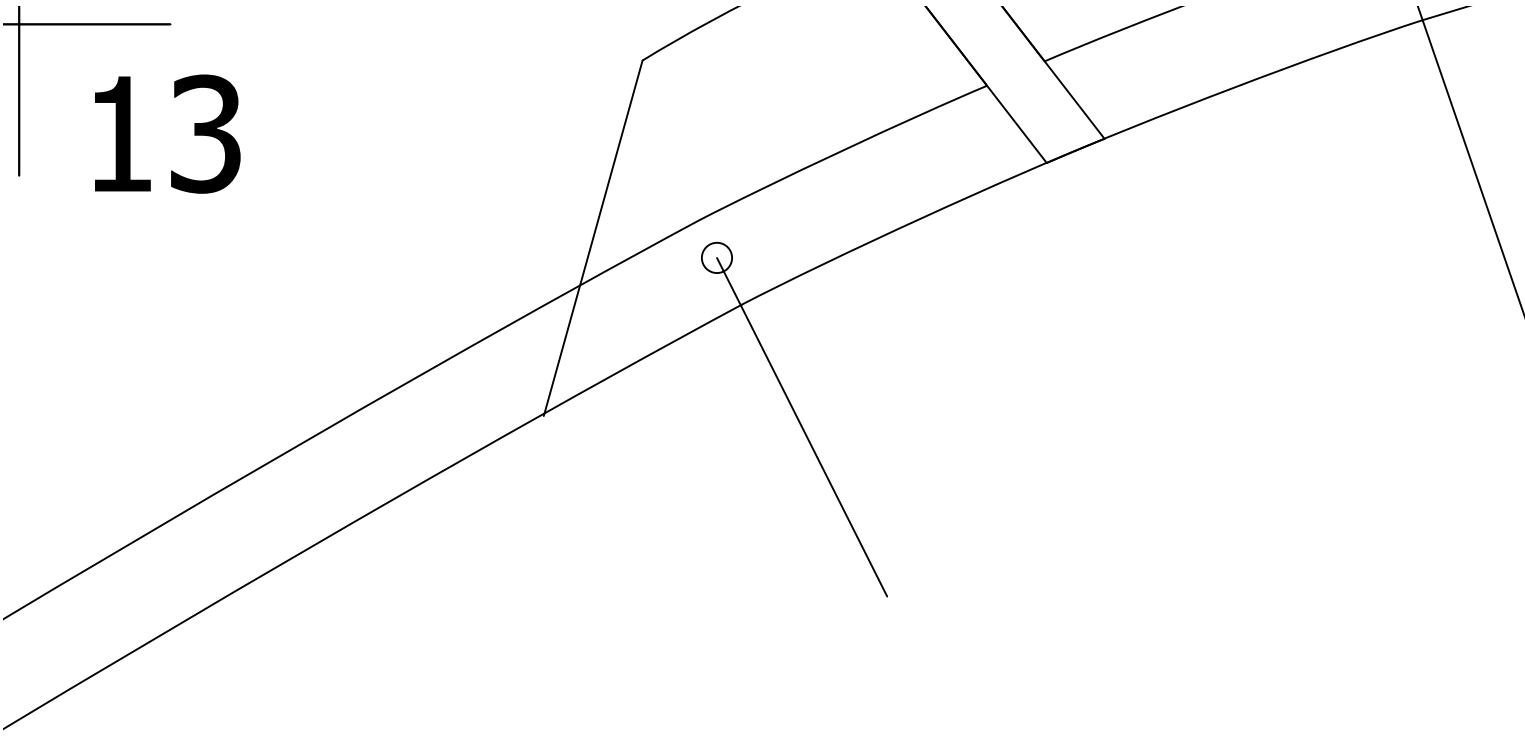

14

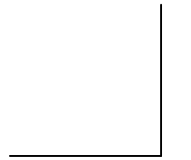
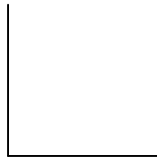
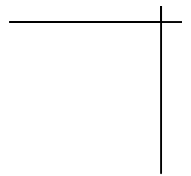
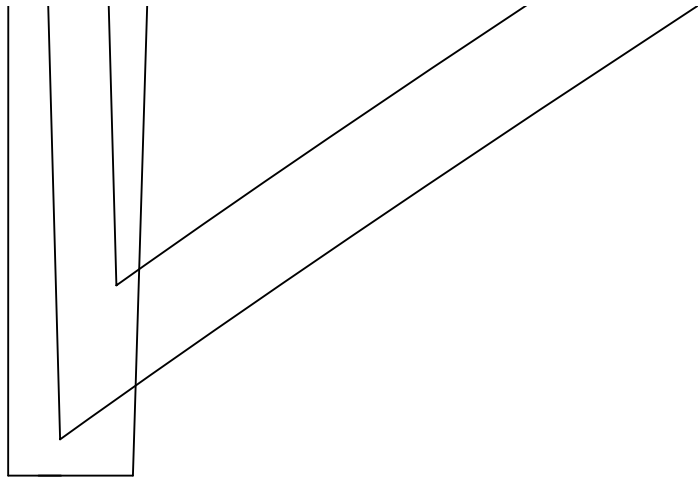

Mallen "Le Quartz par Christian Derefat"

Icarex of Chikara

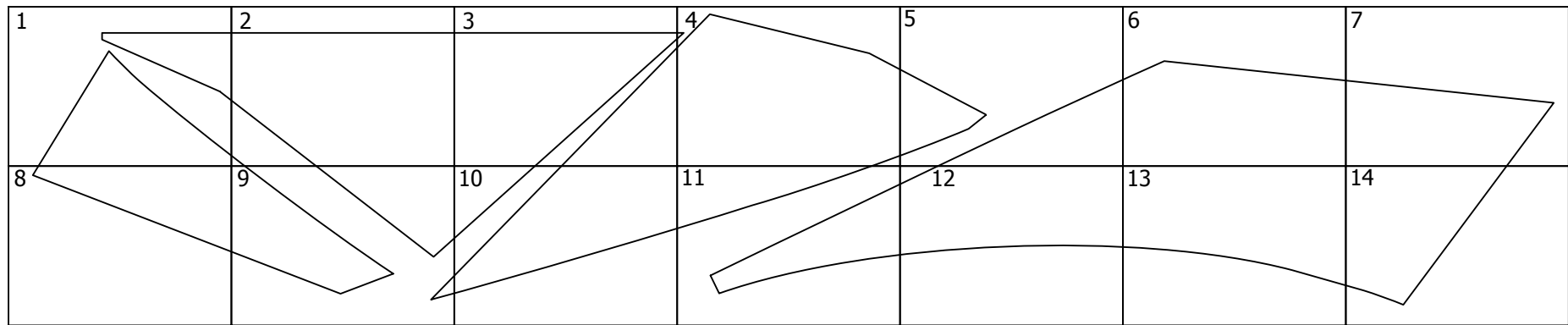

Dacron 50mm breed

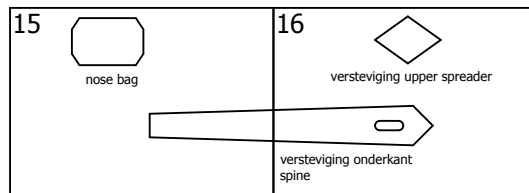

Mylar

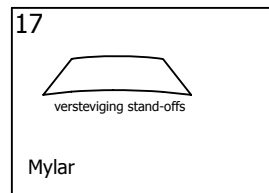

versleten sportzak of autogordel

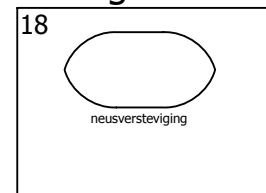

1

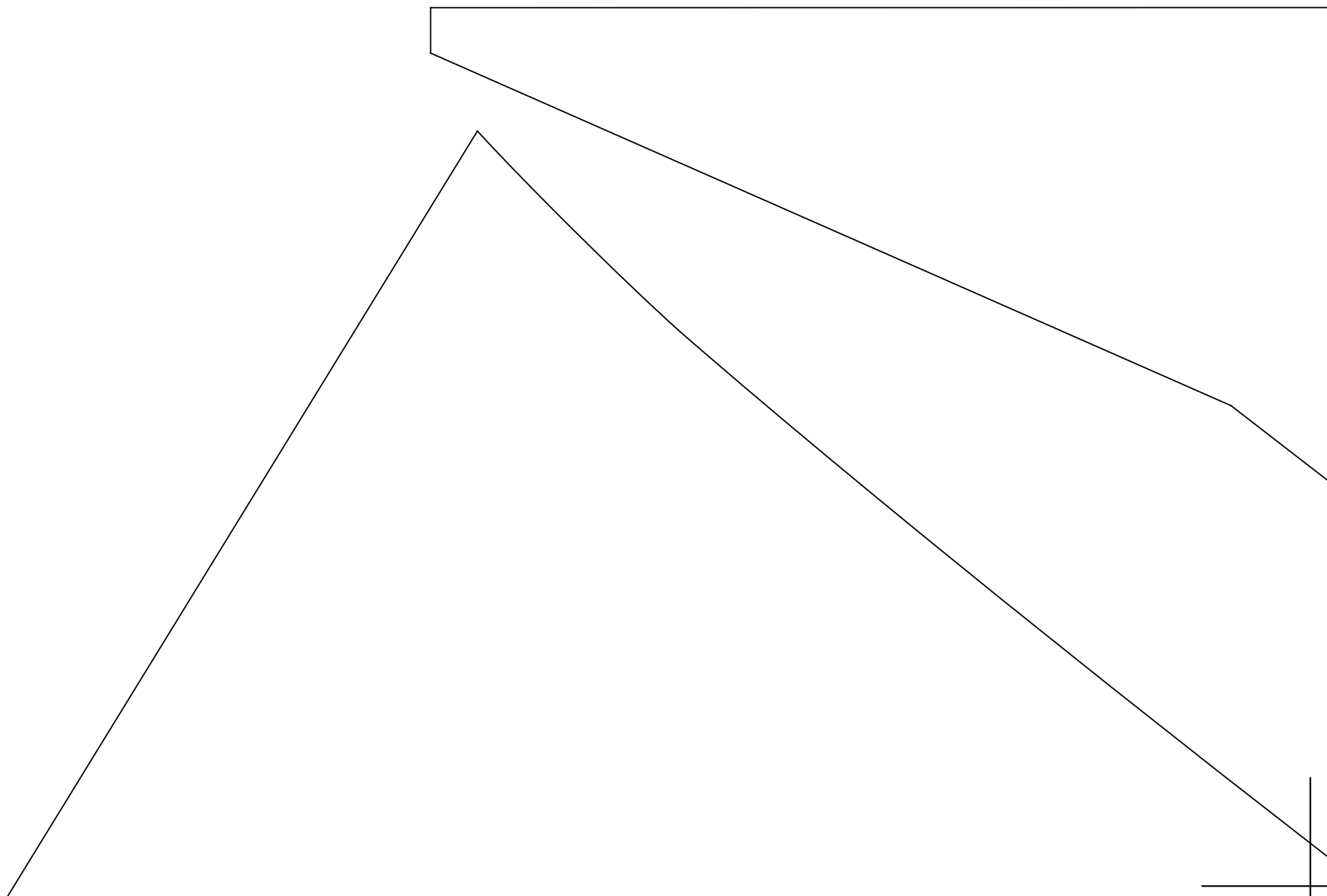

2

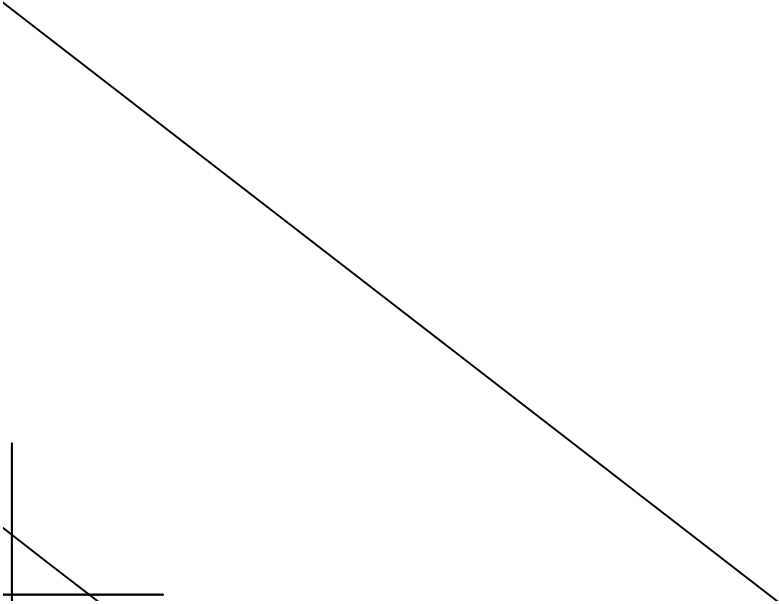

3

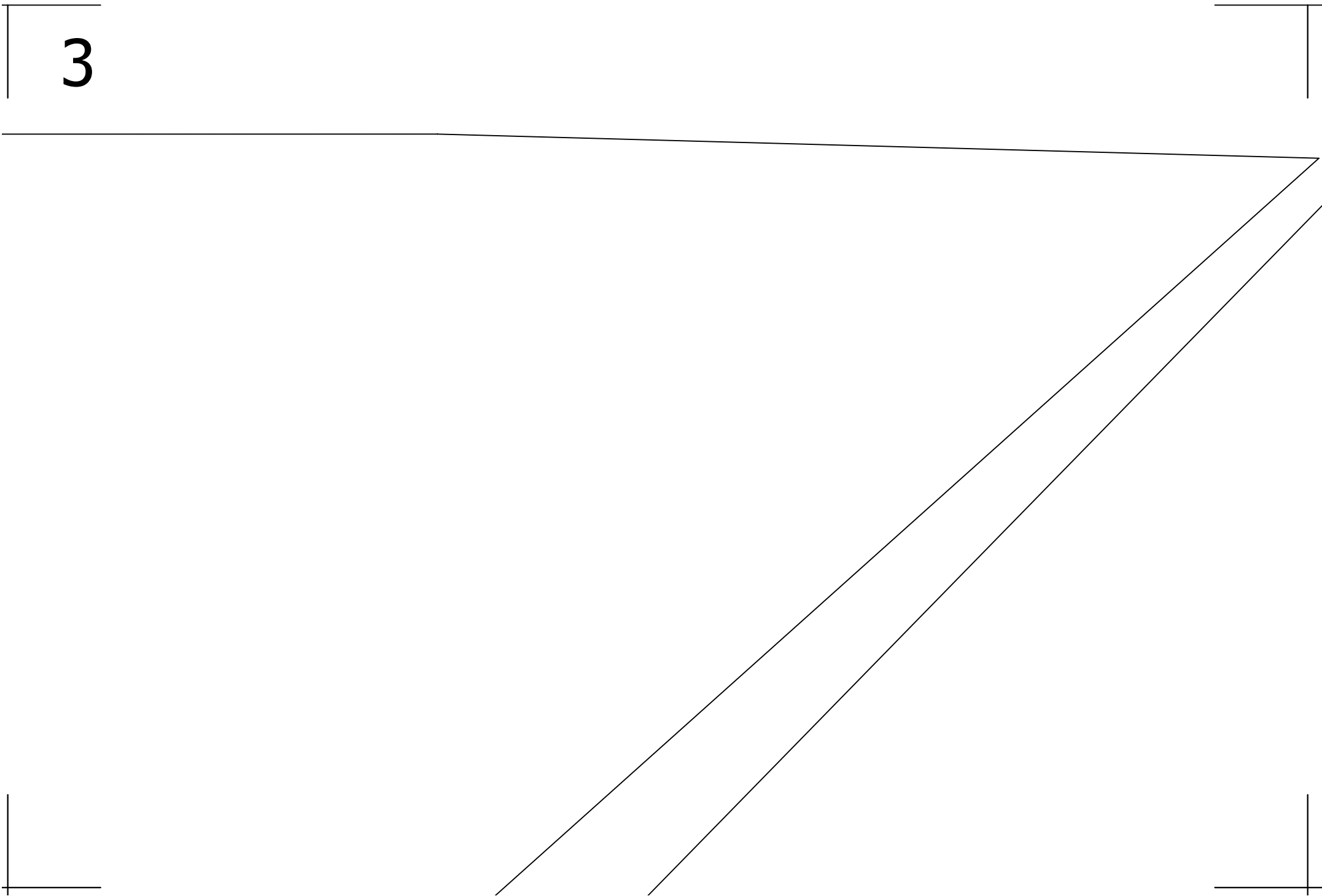

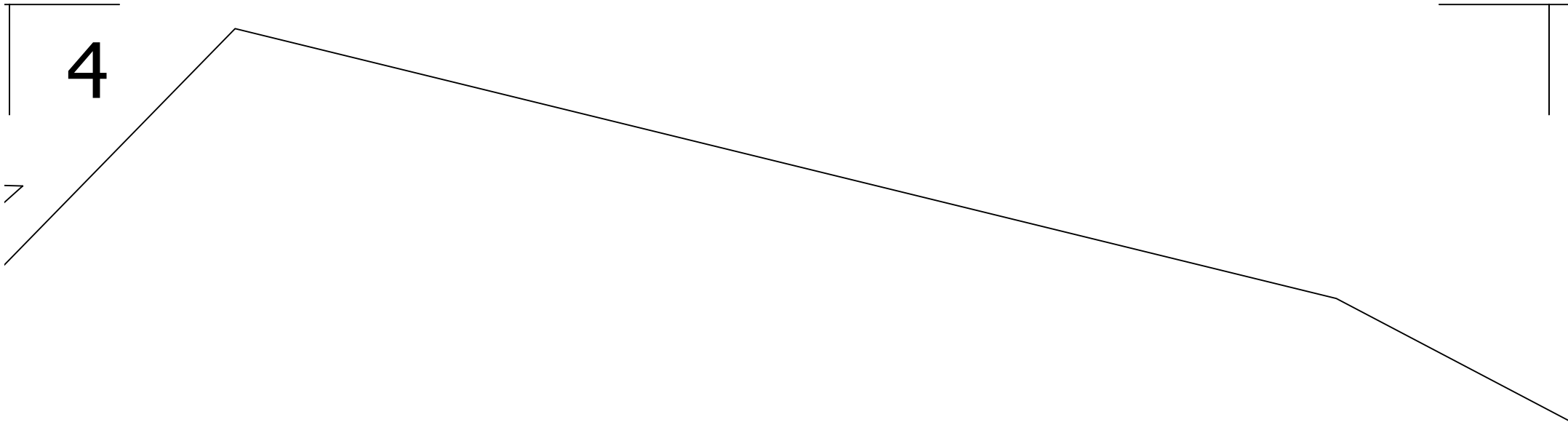

5

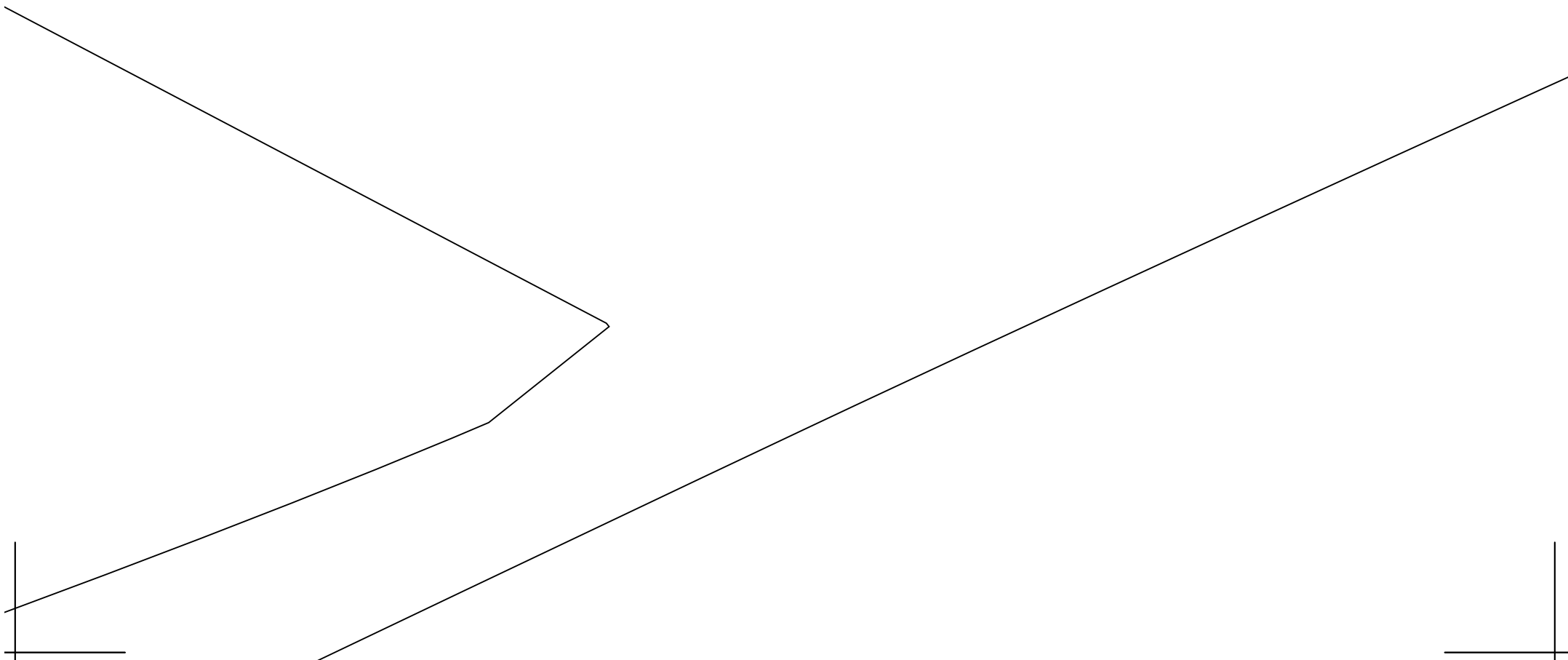

6

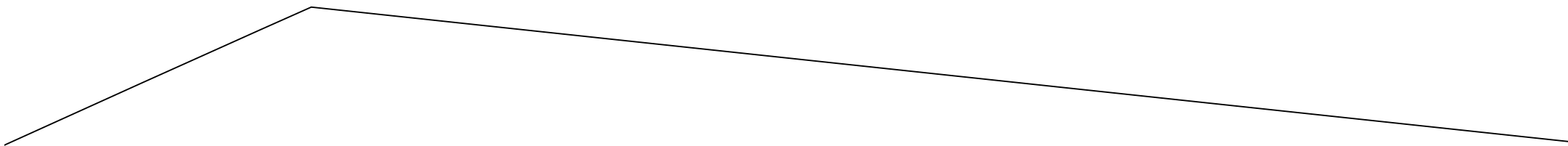
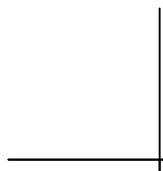
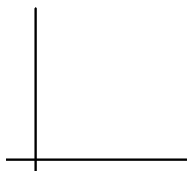
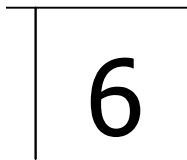

7

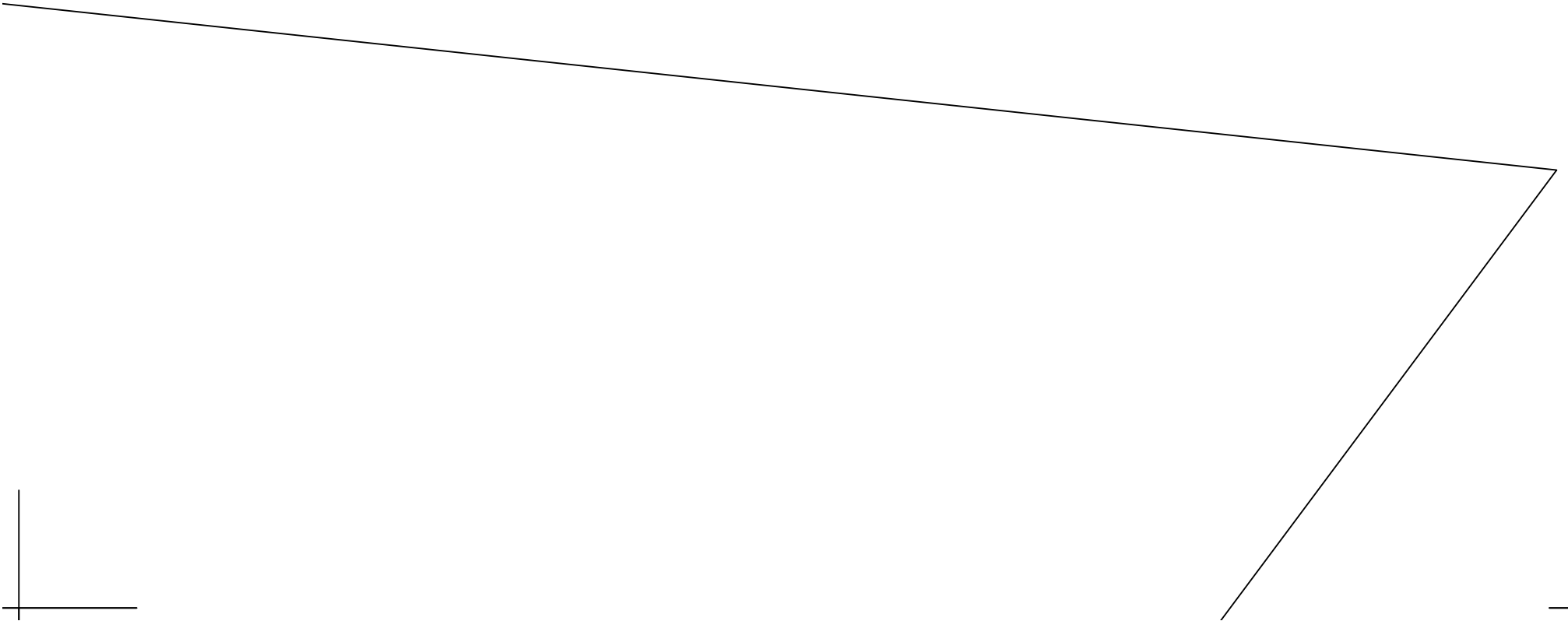

8

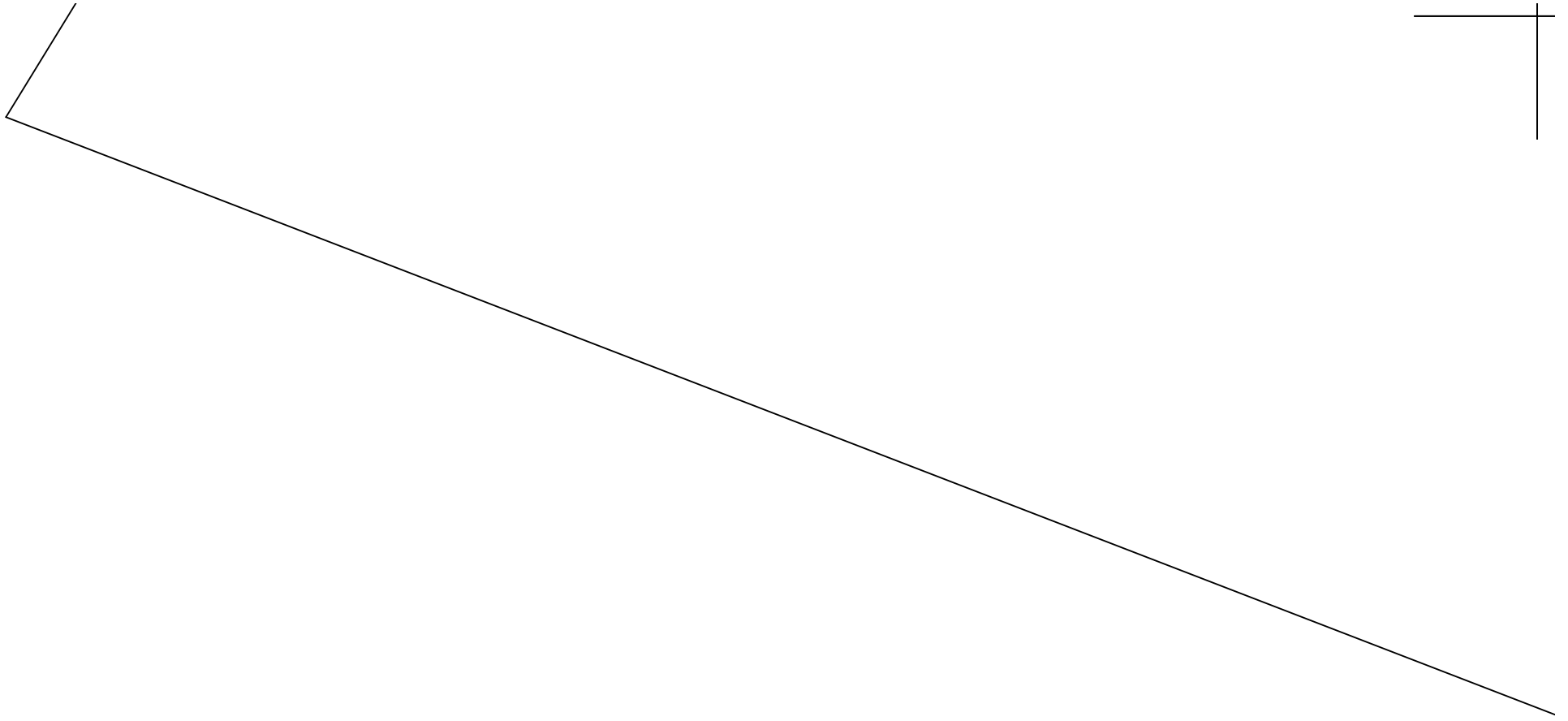

9

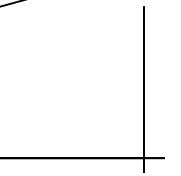
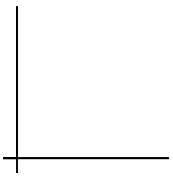
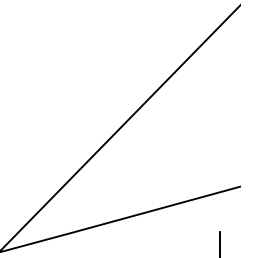
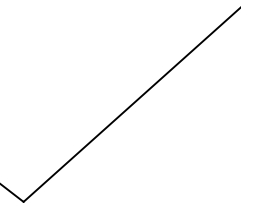
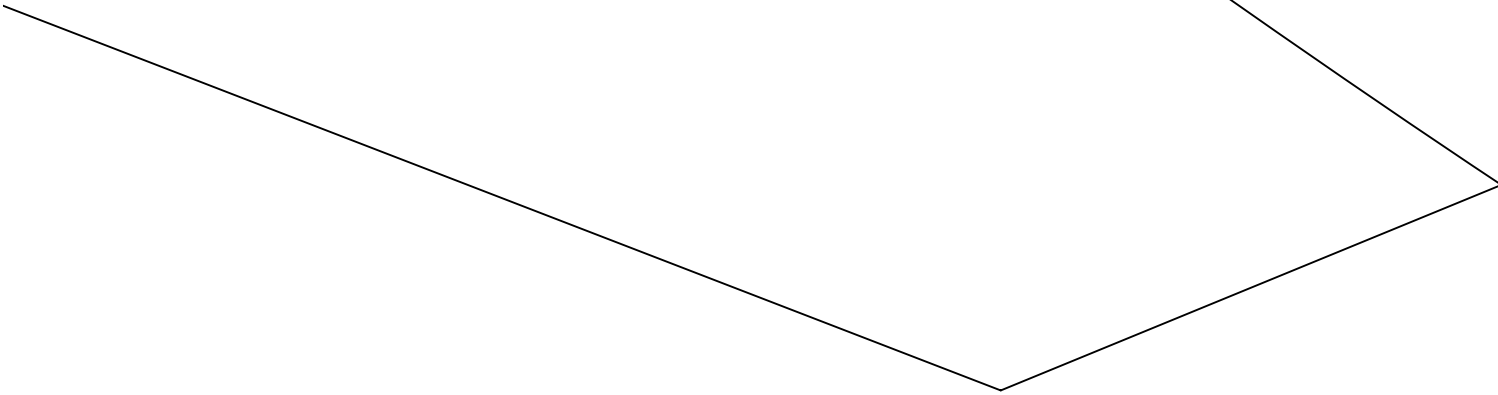
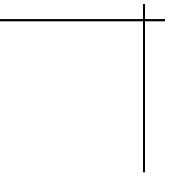
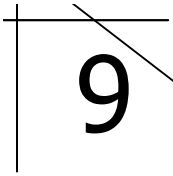

10

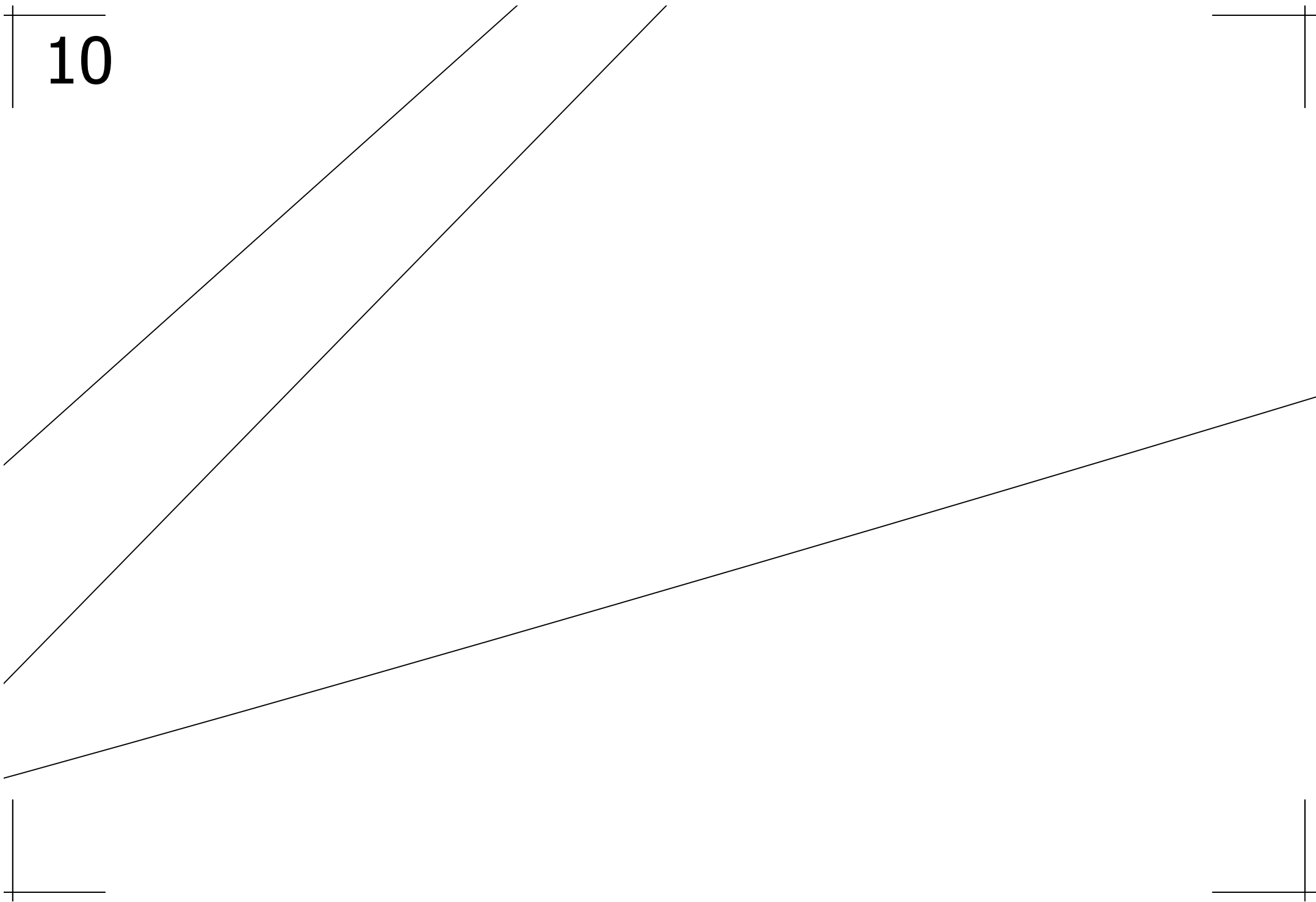

11

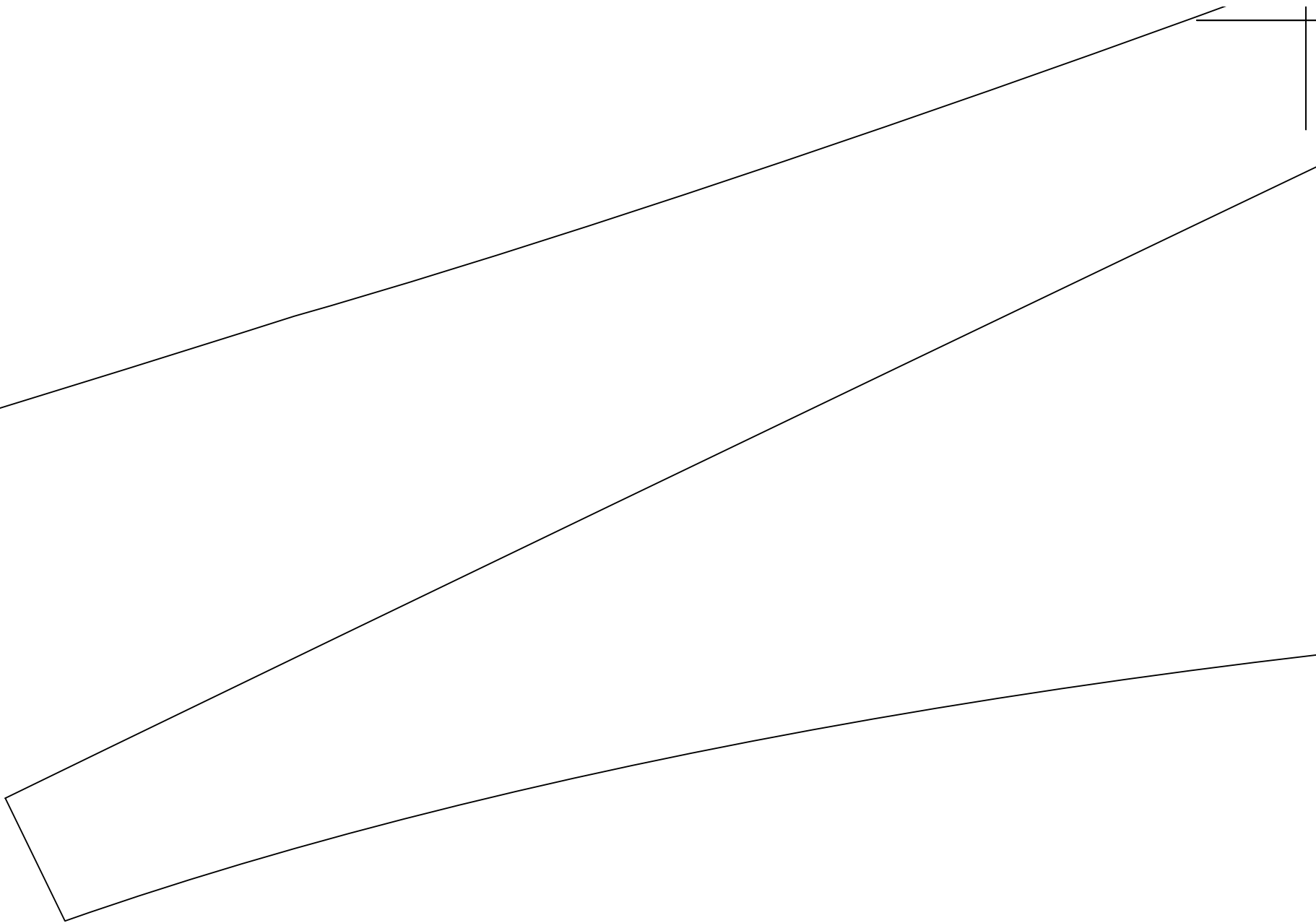

12

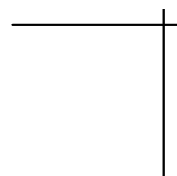
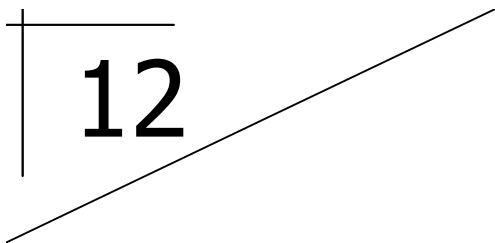

13

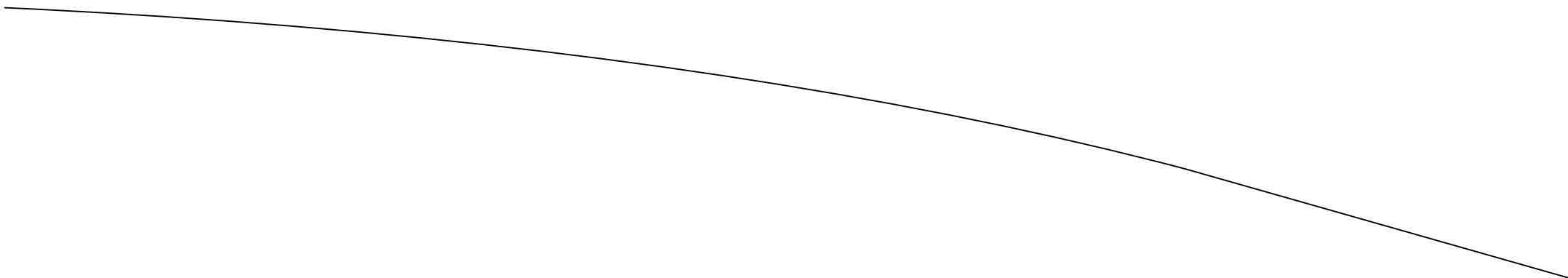

14

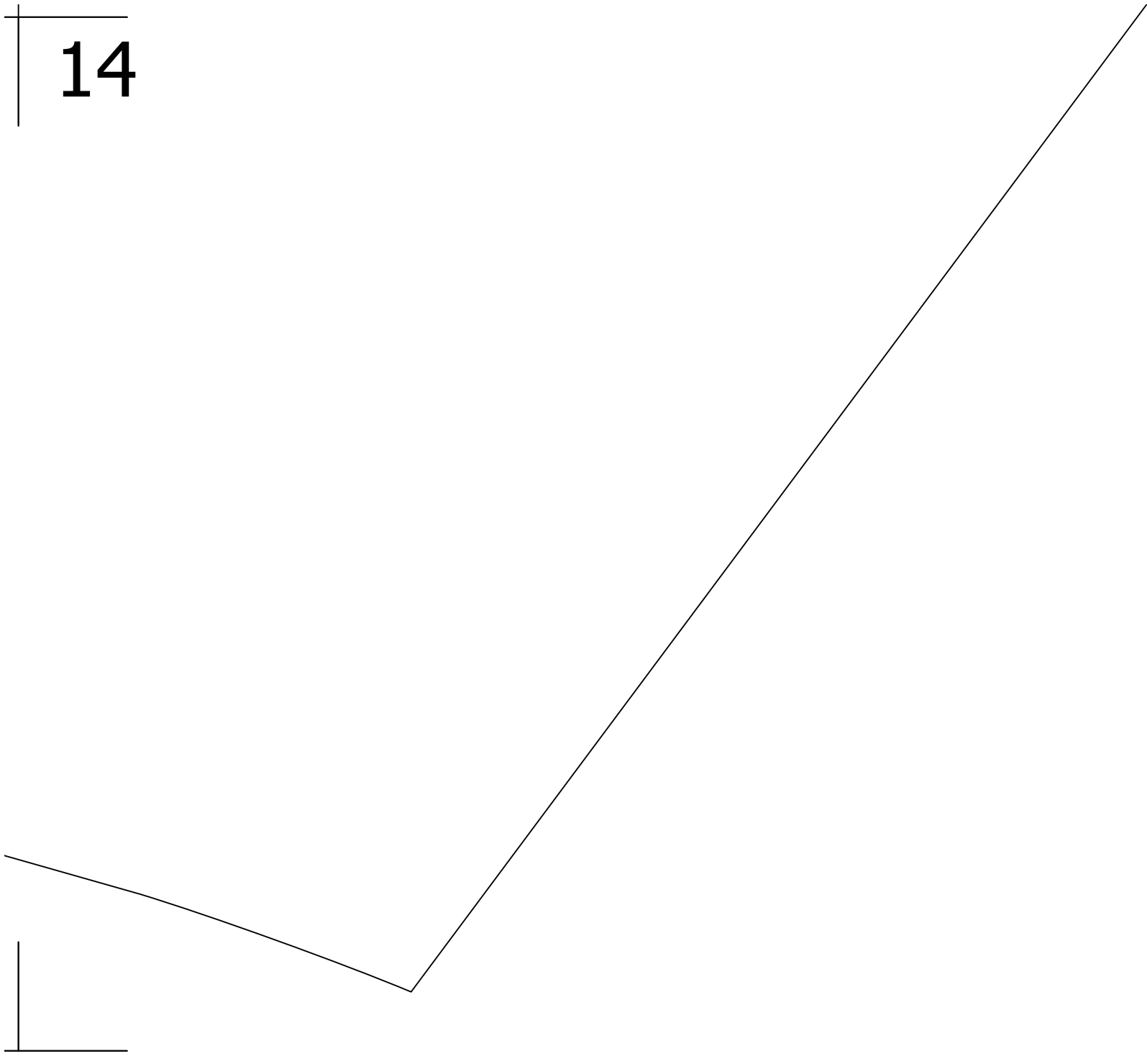
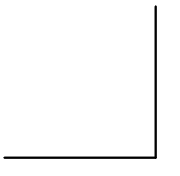
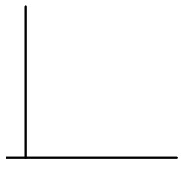
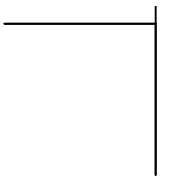
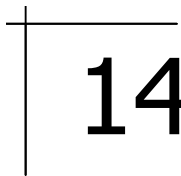

15

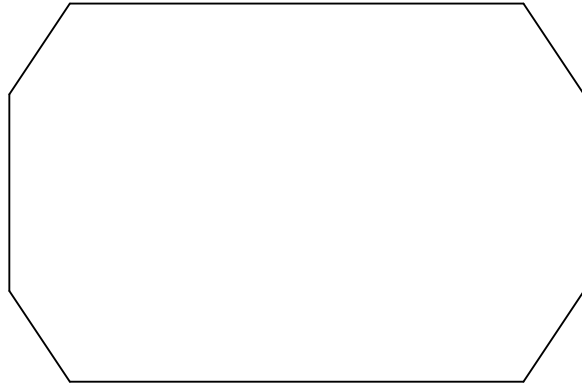

nose bag

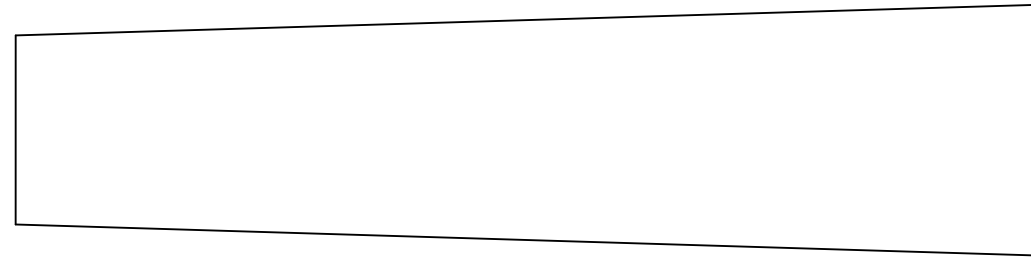

Dacron 50mm breed

16

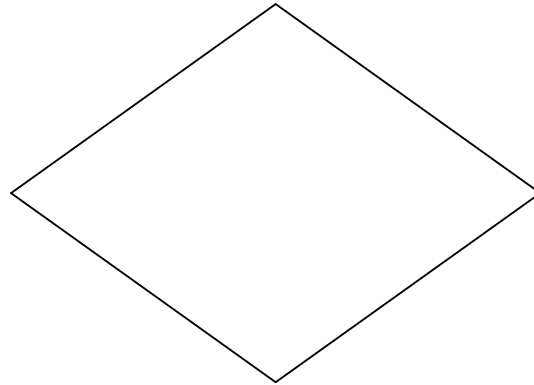

versteving upper spreader

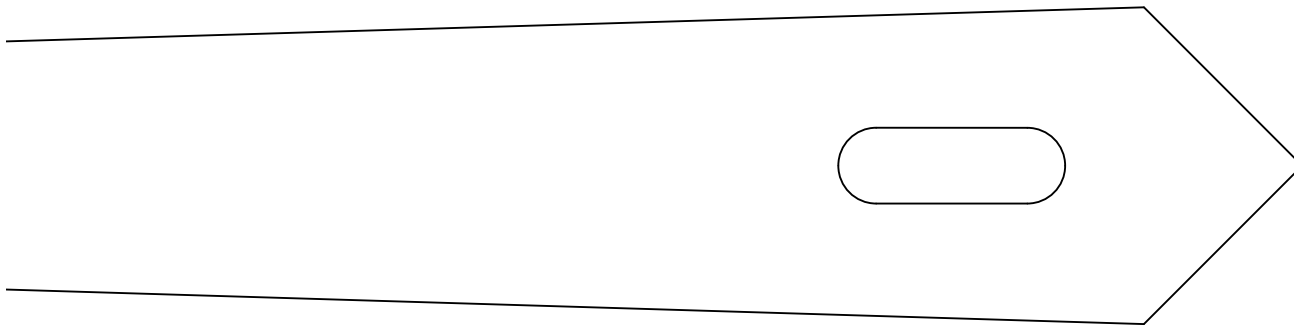

versteving onderkant
spine

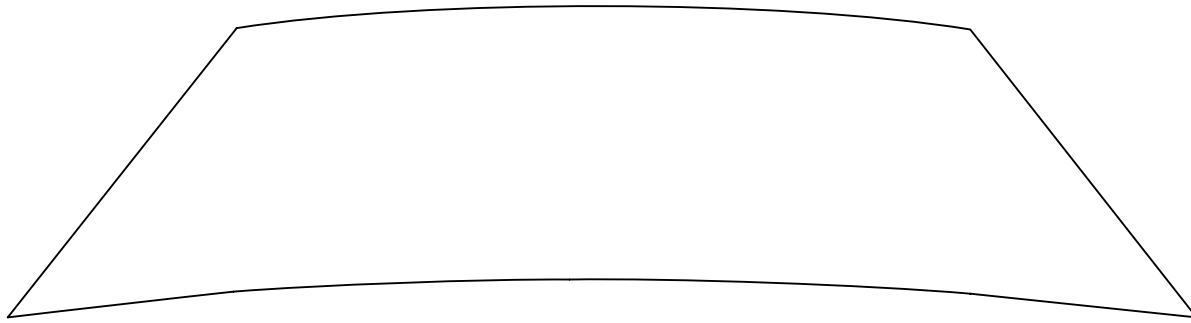

versteviging stand-offs

Mylar

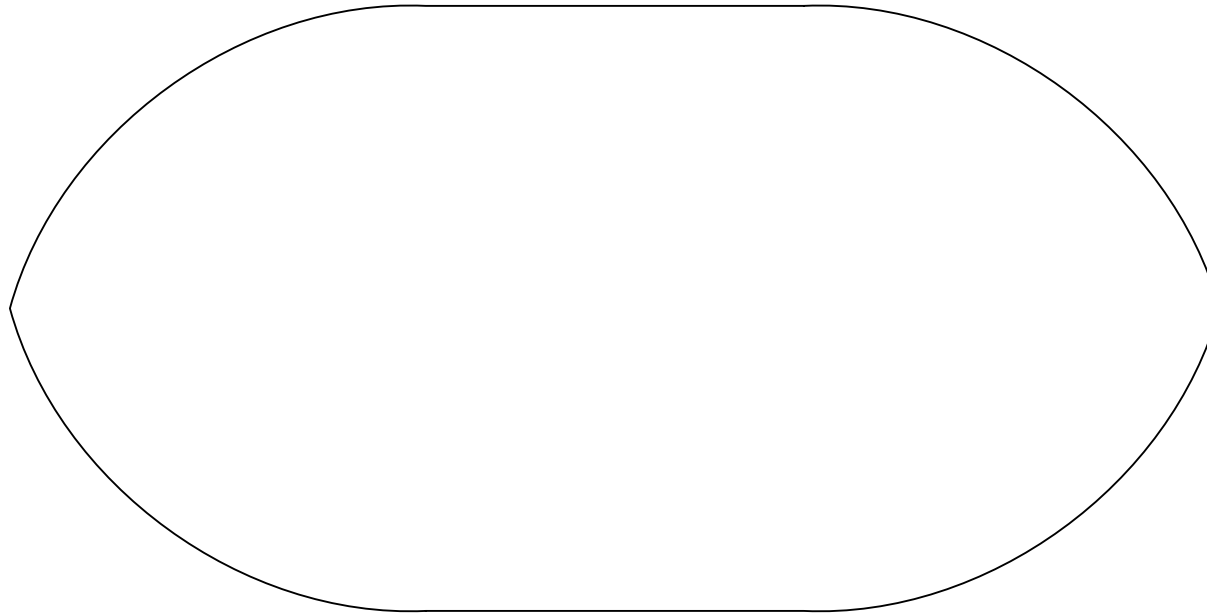

neusversteving

versleten sportzak of
autogordel